

Installation manual for 2116D32C/RC

Dimensions : D32" H5.11" L20

Collection : CUVETTE

Bulb Type : G9 bulb, not include bulb

Lamp Frame Weight : 39.6 LBS

Total Weight : 50.16 LBS



Thank you for choosing our product(s).

Our Company is actively involved in every step of the production.

Our product(s) are designed to be utilized for every application that graces your home or business.

We pride ourselves in providing the most prompt and courtesy service to all of the valued customers.

Please find the enclosed detailed instruction and read carefully for proper installation.

If you have any questions, please contact the retailer Where the purchased was made.

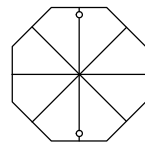

SAFETY

Warning: MAKE SURE THE ELECTRICITY TO THE WIRES YOU ARE WORKING ON IS SHUT OFF. BY EITHER REMOVING THE FUSE OR TURNING OFF THE CIRCUIT BREAKER.

CAUTION

- Before assembling the lighting fixture, please read all instructions carefully.
- All frame & crystal components are fragile, please handle with care.
- Required supply circuit : 110 - 130V/60Hz
- Labeled wires are "L" for live wire, "N" for neutral wire, "E" for ground wire.
- Never install fixture on damp ceiling, the room should be dry and well ventilated
- All electrical components must be installed by a licensed electrician and in accordance with the National Electrical Code and the appropriate local electrical codes.

Unpack the Package

Please open the box carefully and check all the items are inside the box. If you have any installation, assembling and missing parts questions. where you purchase from and any other relevant information ready, our customer service team will provide comprehensive and worry free service to our valued customers.

Frame Assembly Diagram

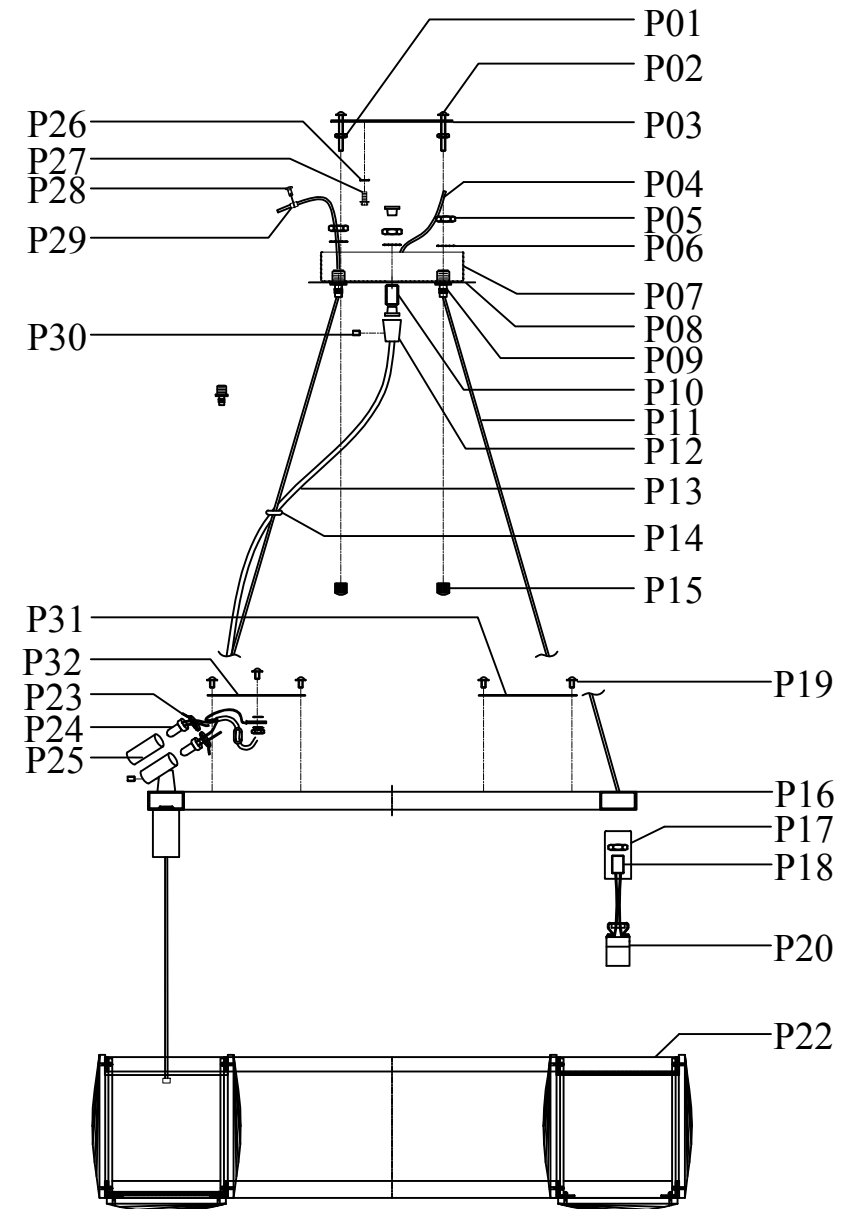













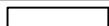







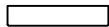





2116D32 D32" H5.11" L20











Step 1

Please use the parts list to ensure you are not missing any parts.

2116D32

| part | picture | Description | Qty | Check list |
|---------|---|--|-----|------------|
| ZA |  | Electrical box(not include) | 1 | |
| ZB |  | GND | 1 | |
| ZC |  | Junction Caps | 3 | |
| ZD(P03) |  | Mounting bracket(L6.7"*W6.7") | 1 | |
| ZE(P07) |  | Canopy(φ7.1"H1",Chrome) | 1 | |
| ZF(P15) |  | M4 Knurled nut | 4 | |
| ZG |  | Mounting bracket screw | 2 | |
| P01 |  | M4 Hex nut | 4 | |
| P02 |  | M4 Mounting bracket screw(L1.2") | 4 | |
| P03 |  | Mounting bracket(L6.7"*W6.7") | 1 | |
| P04 |  | GND | 1 | |
| P05 |  | M10 Hex nut | 24 | |
| P06 |  | M10 Lock washer | 25 | |
| P07 |  | Canopy(φ7.1"H1",Chrome) | 1 | |
| P08 |  | Round stainless steel plate(φ7.9"T0.03") | 1 | |
| P09 |  | Cable adjustment bolt | 4 | |
| P10 |  | M10 Nipple (L0.8") | 2 | |
| P11 |  | Steel cope L118" | 4 | |
| P12 |  | Power wire adjustment bolt | 2 | |
| P13 |  | Clear Round Electrical Wire(L141.7",18#) | 1 | |
| P14 |  | Plastic washer | 2 | |
| P15 |  | M4 Knurled nut | 4 | |
| P16 |  | Pipe ring body (Ø27.4"H0.6") | 1 | |
| P17 |  | Socket cover(Ø0.9"H1.7",Chrome,Iron) | 20 | |
| P18 |  | M10 Nipple (L0.6") | 20 | |
| P19 |  | M4 Flange bolt(L0.23") | 9 | |
| P20 |  | G9 Socket | 20 | |

2116D32 D32" H5.11" L20

| Part | Picture | Description | Qty | Check list |
|------|---|--|-----|------------|
| P22 |  | Crystal frame body with crystal (Ø32"H5.11") | 1 | |
| P23 |  | Cable tie | 6 | |
| P24 |  | Junction caps | 6 | |
| P25 |  | Heat shrink tubing | 6 | |
| P26 |  | M10 Lock washer | 4 | |
| P27 |  | Ground screw | 1 | |
| P28 |  | M4 Nipple | 8 | |
| P29 |  | Wire rope clamp | 8 | |
| P30 |  | M4 Plastic Nipple | 2 | |
| P31 |  | Two holes steel bracket A | 3 | |
| P32 |  | Two holes steel bracket B | 1 | |

2116D32 D32" H5.11" L20

| Part | Picture | Description | Qty | Check list |
|------|---------|-------------|-----|------------|
| | | | | |
| | | | | |
| | | | | |
| | | | | |
| | | | | |
| | | | | |
| | | | | |
| | | | | |
| | | | | |
| | | | | |
| | | | | |
| | | | | |
| | | | | |
| | | | | |
| | | | | |
| | | | | |
| | | | | |
| | | | | |
| | | | | |
| | | | | |
| | | | | |

2116D32 D32" H5.11" L20

| Part | Picture | Description | Qty | Check list |
|------|---------|-------------|-----|------------|
| | | | | |
| | | | | |
| | | | | |
| | | | | |
| | | | | |
| | | | | |
| | | | | |
| | | | | |
| | | | | |
| | | | | |
| | | | | |
| | | | | |
| | | | | |
| | | | | |
| | | | | |
| | | | | |
| | | | | |
| | | | | |
| | | | | |
| | | | | |
| | | | | |
| | | | | |

Step 2

Canopy Installation Instruction

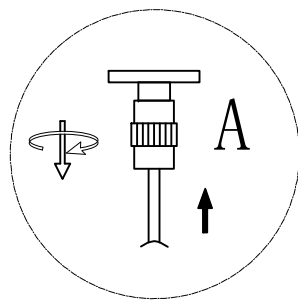
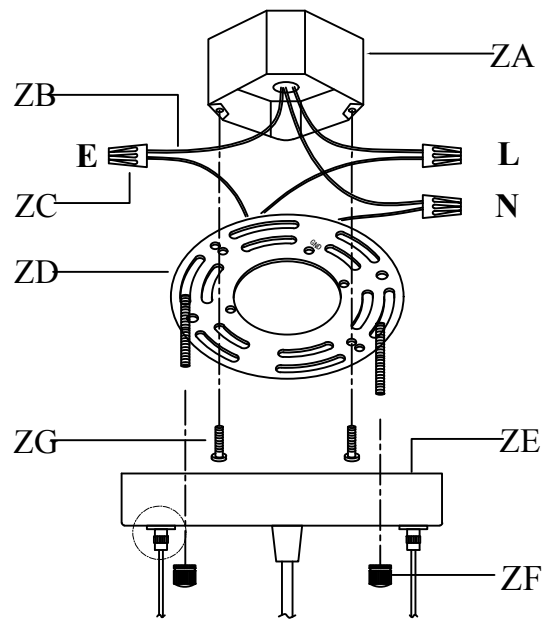

When adjusting the height of the steel wire, the telescopic metal part A toothed outer ring can only twist half a turn, and then pull it up to adjust the height!!!

"L"=Hot wire
"N"=Neutral wire
"E"=GND

07

IMPORTANT: Test sockets with bulb before dressing the fixture.

- 1 .Attach the Mounting bracket (ZD) to the electrical box (ZA).
- 2 .Pull wires up through the Junction Caps (ZC).
- 3 .Attach the Canopy (ZE) to the ceiling panel.
- 4 .Make the electrical connections as detailed in the drawing above.

08

Step 3

Frame Assembly Diagram

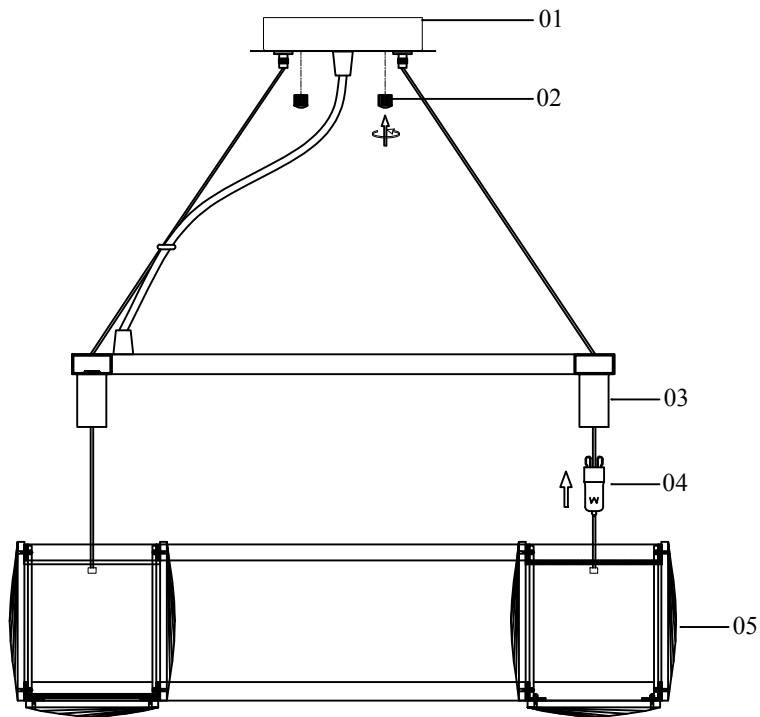

Frame Assembly Instructions

Installation:

Please read all instructions carefully. Before you proceed to install make sure that the power supply is turned off and remains off until installation is complete. Please note that each part has been assigned a number. Please proceed in a numerical order.

1. Install G9 Bulb(04) to G9 Socket(03).
2. Put the Light body ring on Crystal frame body with crystal (05).
3. Use Knurled nut(02) to fasten Canopy(01) together with Mounting bracket of Ceiling panel.

Congratulations !

You are now done installing your Elegant Lighting fixture. Sit back and admire each crystal as it will become the statement piece for your room/house.

Thank you.

Cleaning and Maintenance of Chandelier Frame
The finish on our chandelier frames and fixture frames is protected by a durable coating of lacquer. To clean, use a clean soft, dry cloth. Do not use any metal polishes, cleaners, abrasives or any substance which could remove the protective finish. Failure to follow these instructions automatically voids the guarantee.

Cleaning and Maintenance of Crystals
Wet a soft cotton fabric in clean warm water and wipe gently, then polish with a dry soft cotton fabric.

To Order Crystal Replacement Parts
Should you require replacement crystals or pins (the metal connectors attaching the crystals), contact the store where the product was purchased or contact us . For ease of ordering, you may use the original crystal trimming instructions provided with this product and circle the items you wish to order, indicating the quantity by writing the number needed adjacent to the circle . You will be contacted with prices prior to shipment. All orders must be pre-paid.

Elegant Lighting Warranty

The finish and frame of your new chandelier or fixture are warranted for a period of one (1) year from the date of purchase. Our company will, at its option, repair or replace any frame that has a defect in the materials or workmanship during the warranty period. All crystals are guaranteed for their original quality during the life of the chandelier. Breakage is not covered by this warranty.

To make a claim under this warranty, contact our customer service department.

A written return authorization form will be sent to you with specific instructions.

Returns and Conditions of Warranty

Returns must be pre-authorized by contacting our customer service department. Returns will only be accepted with a written return merchandise authorization and return shipping charges pre-paid. We reserve the right to inspect all returned merchandise to fully determine the nature of any defect. This guarantee shall not apply to any product that has been changed, altered or otherwise modified, nor shall it apply to any product that has been repaired or altered by anyone other than a pre-authorized facility. We will not be responsible for any breakage or damages incurred during transit, nor for crystal parts or metal frame part that have been subject to misuse, negligence, accident or inappropriate handling. Also, we will not be held responsible for damage incurred during improper installation or wiring by others, nor for damages resulting from a failure to follow the recommended maintenance or installation procedures. This guarantee is issued in lieu of any and all other guaranteed or warranty, whether written or implied and any and all other obligations or liabilities. Further, we neither authorize nor permit any other person or firm to assume for us, any liability in connection with the sale of our products.